

mizu

Mizu Drift Shower Mixer with Diverter

SPECIFICATIONS

Recommended Use	Domestic, Hotel & Commercial
Colour	Chrome
Colour Availability	Chrome, Matte Black, Brushed Nickel
Recommended Pressure Range	150 - 500kPa
Max Continuous Working Pressure	1000kPa
Max Continuous Working Temperature	65°C
Suitable for Storage Tank Hot Water	Yes
Suitable for Continuous Flow Hot Water	Yes
Suitable for Gravity Feed Hot Water	No

Hot and Cold water inlet pressure should be equal

WARRANTY

Warranty - Domestic Use	7 Years
Spare Parts & Labour	12 Months

Please refer to Warranty Page for full Terms and Conditions

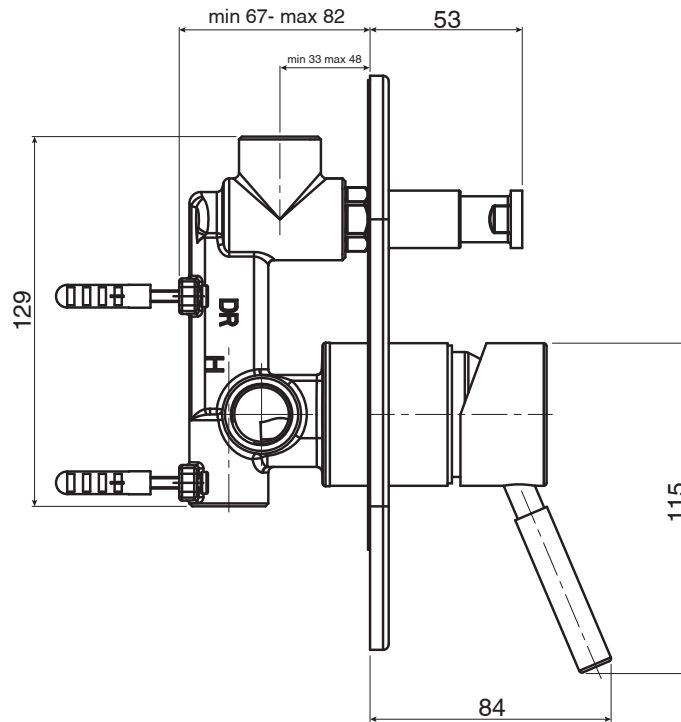
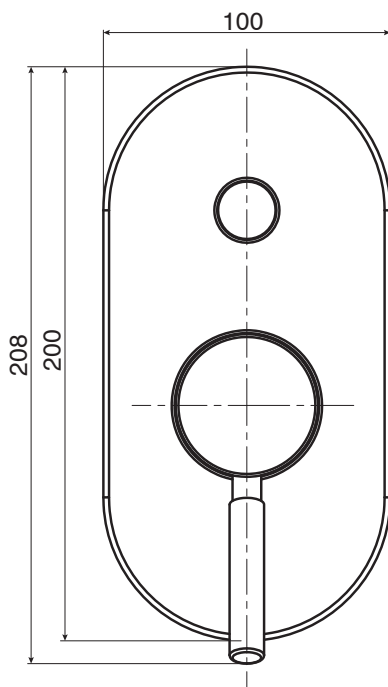

Dimensions are nominal measurements only.

Disclaimer: Products in this specification manual must by regulation be installed by licensed and registered trade people. The manufacturer/distributor reserves the right to vary specifications or delete models from their range without prior notification. Dimensions are nominal measurements only. Dimensions and set-outs listed are correct at time of publication however the manufacturer/distributor takes no responsibility for printing errors.

Published 05/09/2018

To see the complete Mizu range go to www.reece.com.au/bathrooms

