

# RIFCO

## IVY WALL HUNG VANITY



To see the complete Rifco range go to  
[www.reece.com.au/bathroom](http://www.reece.com.au/bathroom)

### SPECIFICATIONS

Recommended use	Domestic, Commercial and Hotel
Materials	Cabinetry - Moisture Resistant Melamine Board
Basin Features	20mm acrylic top with moulded basin in left, right or centred position.
Cabinet Finish	External: Polyurethane or Polytec laminate options. Internal: Moisture Resistant Melamine Board finish.
Fixing	Bolted to wall by Licensed Tradesperson
Features	Optional soft close internal drawer

### STANDARD SIZES

Width (mm)	600	750	900	1200
Depth (mm)	460	460	460	460
Height (mm)	520	520	520	520
No. of doors	2	2	2	3
Tapholes	0,1 or 3	0,1 or 3	0,1 or 3	0,1 or 3

Disclaimer: Products in this specification manual must by regulation be installed by licensed and registered tradespeople. The manufacturer/distributor reserves the right to vary specifications or delete models from their range without prior notification. Dimensions are nominal measurements only. Dimensions and setouts listed are correct at time of publication however the manufacturer/distributor takes no responsibility for printing errors.

## IVY WALL HUNG VANITY

### STANDARD SIZES

600 – 900 WIDTH – FRONT VIEW

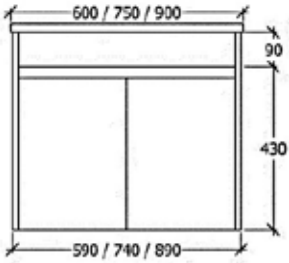

1200 WIDTH – FRONT VIEW

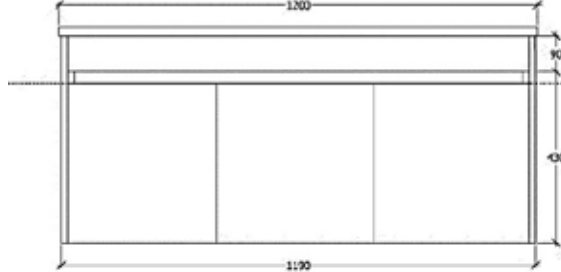

SIDE VIEW

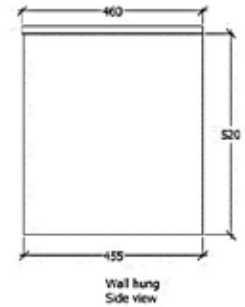

### ICON' ACRYLIC TOP

Left hand bowl

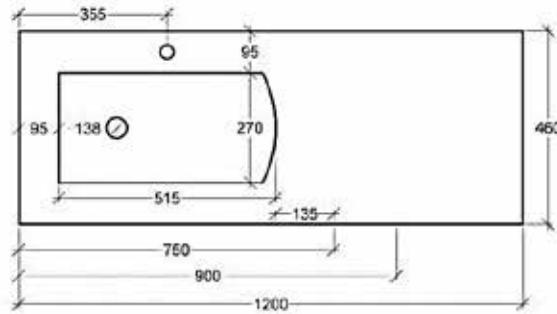
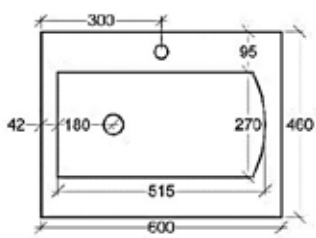

Right hand bowl

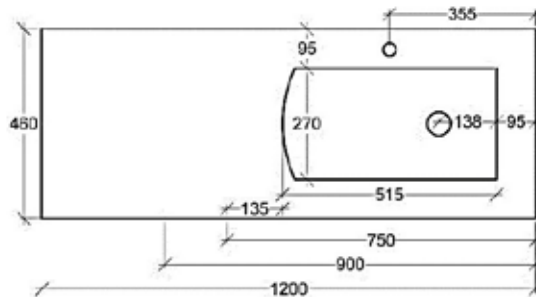
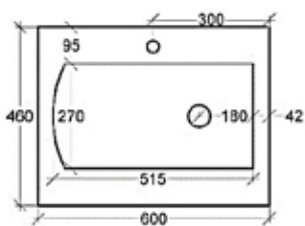

### 'STADIUM' ACRYLIC TOP – CENTRED BOWL

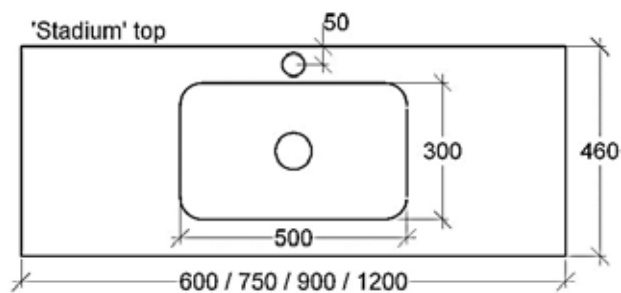

Dimensions are nominal measurements only

# RIFCO

## IVY WALL HUNG VANITY COLOUR OPTIONS

### POLYTEC CABINET – MATTE/SHEEN OPTIONS

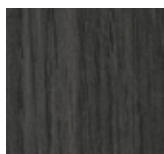

Shannon Oak



Rocco Lini



Gesso Lini

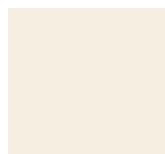

Café Cream



Black Wenge (Matte only)

### POLYTEC CABINET – RAVINE/LEGATO OPTIONS



Bleached Walnut



Drifted Oak



Maison Oak



Maroso Milan

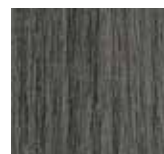

Char Oak (Ravine only)

### CLEANING RECOMMENDATIONS – ACRYLIC TOPS

Minimal maintenance is required. Regularly wipe down with an absorbent cloth or towel to remove pooled water build-up of soap/toothpaste scum. If required, wipe down with an approved liquid cleanser. This product should not be cleaned with abrasive materials. Damage caused by any improper treatment is not covered by the product warranty - refer to Warranty Conditions.

Plumbers, please ensure of a copy of the installation instructions is left with the end user for future reference.

# IVY WALL HUNG VANITY

## INSTALLATION INSTRUCTIONS

### A licensed tradesperson must install your Rifco Vanity.

It is the responsibility of the purchaser to examine and check the Rifco Vanity for both suitability and quality BEFORE installation.

If the unit is not in good order and condition do not install. Please contact the retailer where the Vanity was purchased for further instructions. Rifco accepts no responsibility once partially or fully installed.

Remove drawers from vanity.

Locate tab under each side of drawer, located on the underside of the drawer at the front.

Pull them simultaneously towards you.

Whilst still pulling the tabs, pull the drawer straight back towards you.

The drawer is now free from the locking tabs, pull it out the rest of the way.

It is recommended that the drawer runners are covered to prevent particles/dust blocking the runners.

Remove top from vanity.

Having established the position of the vanity, mark and drill the holes for your plumbing fixtures, i.e. waste outlet, hot and cold water inlets. Move vanity into position and ensure it is level and square. This may require packing behind and/or below the vanity.

Once it is level and square, fix the vanity to the wall using the correct fitting depending on your wall (not supplied). If using standard screws and star plugs, be sure to use the washers in order to spread the load.

Position fixings as shown below:

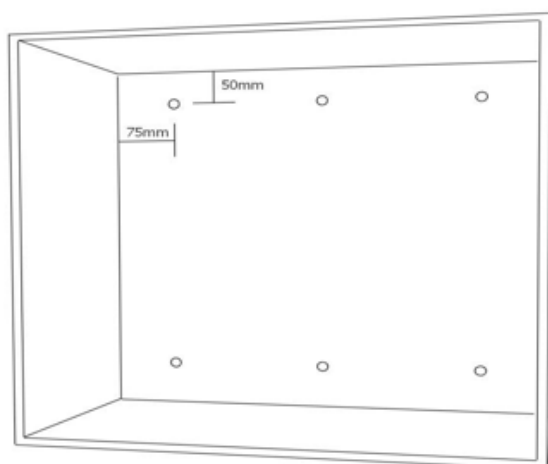

The number of fittings used to fix cabinet will depend on the size of unit, your installer will know the suitable amount depending on the size of your cabinet.

Rifco recommends the following minimum;

Up to 900 width of vanity – 3 per row

900 to 1200 width of vanity – 4 per row

For wall hung vanities, it is essential the unit is fixed securely. The use of dynabolts is recommended for masonry wall, and fixing to studs in cavity walls. Rifco does not recommend installing wall hung vanities with toggle type fixing systems.

Connect the water supply lines and waste outlet

Replace drawers or doors back onto the vanity unit and make any necessary adjustments.

Fix the top to the vanity unit using quality bathroom use silicone. The gap between the wall and top will need to be filled with silicone. The vanity unit must then be sealed to the wall on all edges with silicone.

Plumbers, please ensure of a copy of the installation instructions is left with the end user for future reference.