

ROCA

THE GAP BACK TO WALL BIDET

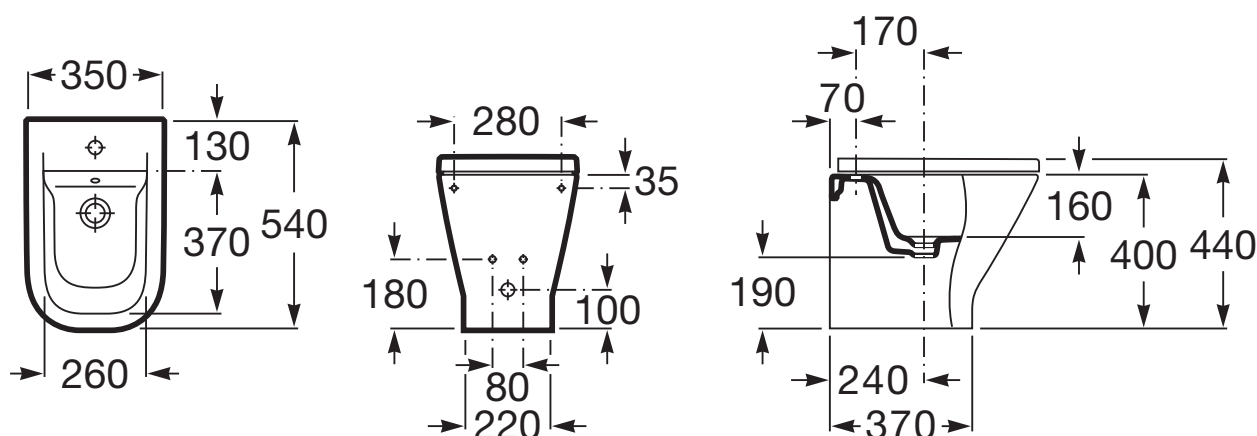

Dimensions are nominal only

SPECIFICATION

Recommended Use	Domestic, hotel and commercial
Fixing	Screwed to the floor and bedded with sealant
Standards	AS 3494
Overflow	Integrated overflow
Weight	22Kg
Seat	Optional



To see the complete Roca range go to www.reece.com.au/bathrooms

CLEANING RECOMMENDATIONS

Soapy water or approved bathroom cleaners. This bathroom product should not be cleaned with abrasive materials. Damage caused by any improper treatment is not covered by the product warranty. Refer to Warranty Page for full Terms and Conditions.

Disclaimer: Products in this specification manual must by regulation be installed by licensed and registered trade people. The manufacturer/distributor reserves the right to vary specifications or delete models from their range without prior notification. Dimensions and set-outs listed are correct at time of publication however the manufacturer/distributor takes no responsibility for printing errors.

Tech Page Version 2

ROCA THE GAP BACK TO WALL BIDET

INSTALLATION

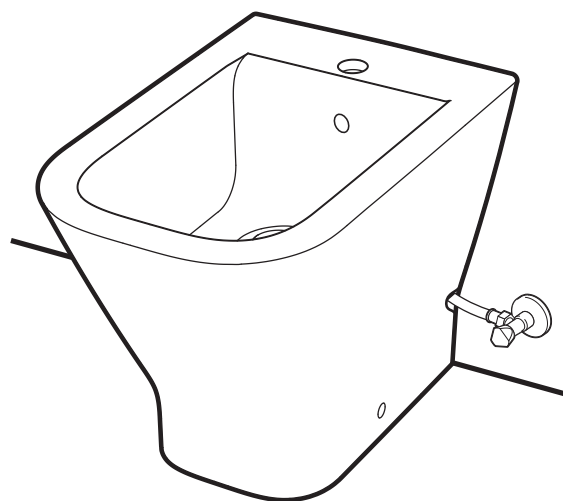
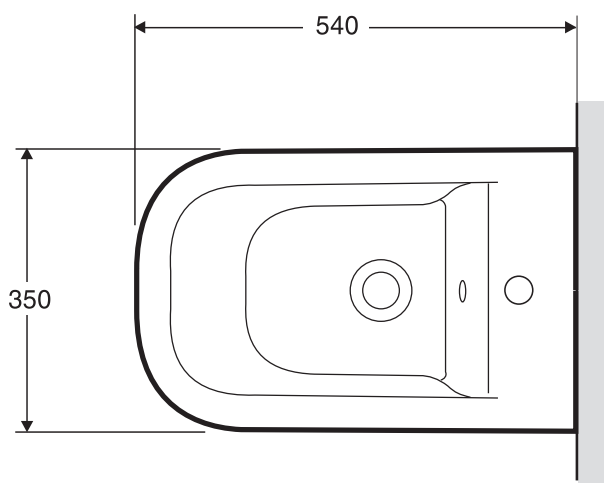
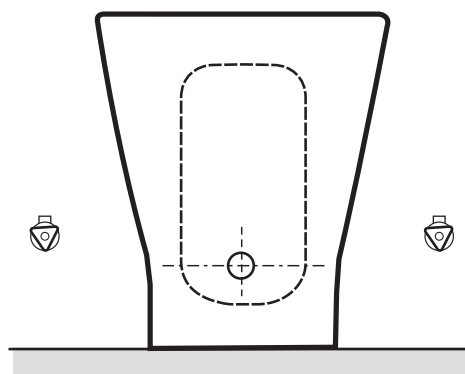
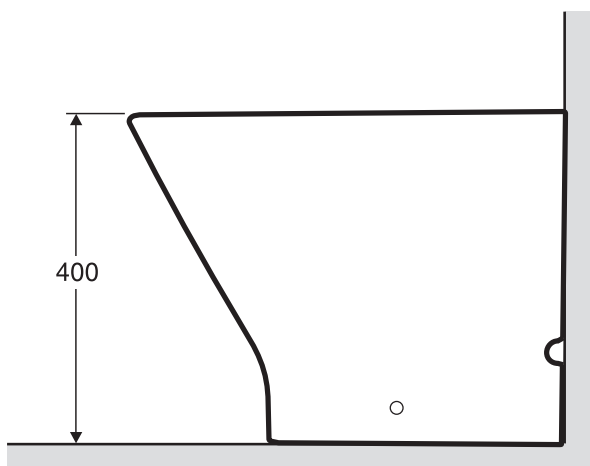

Plumbers, please ensure a copy of the installation instructions is left with the end user for future reference

ROCA

THE GAP WALL FACED BIDET

INSTALLATION

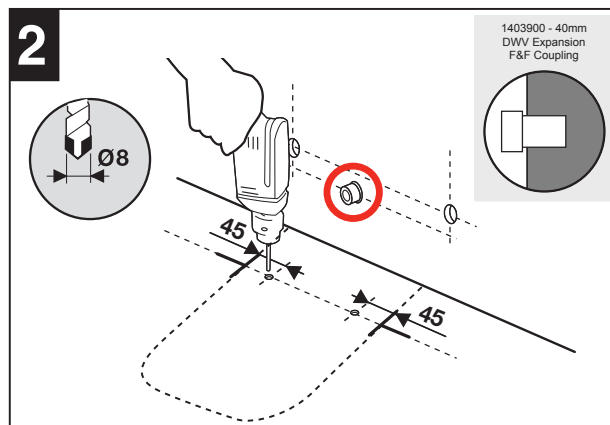
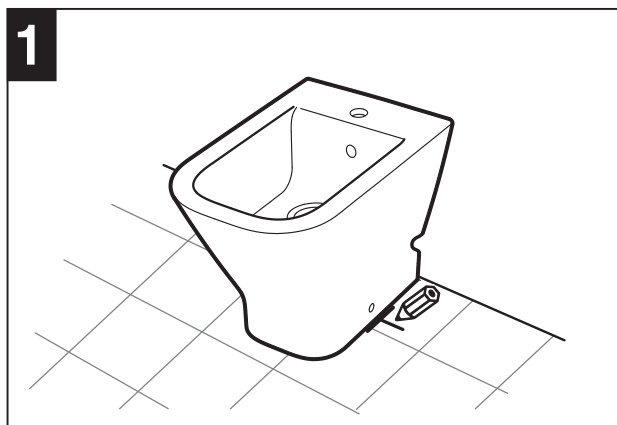

○ When using the recommended lever operated pop up waste (1852365 Mizu Bidet Pop UP Waste 32x4 W/Of CP), a PVC short P trap (1408905) needs to be offset to allow the lever to operate

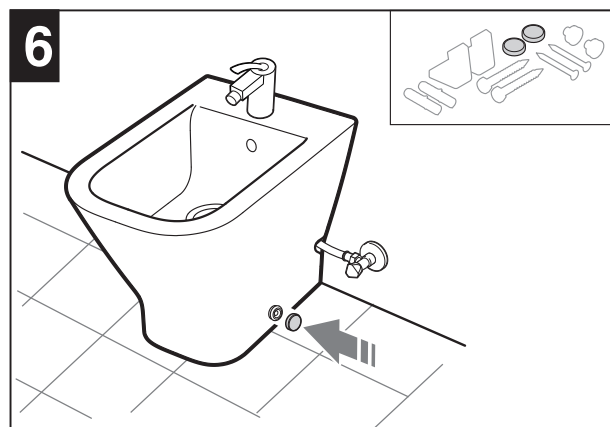
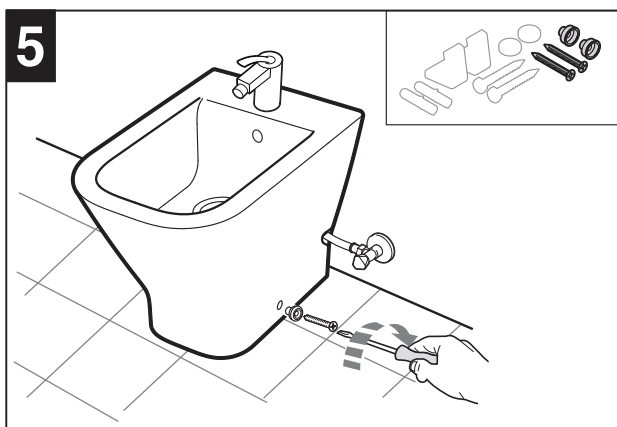
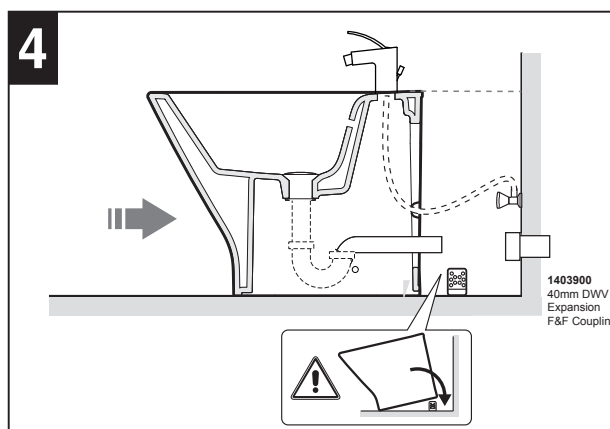
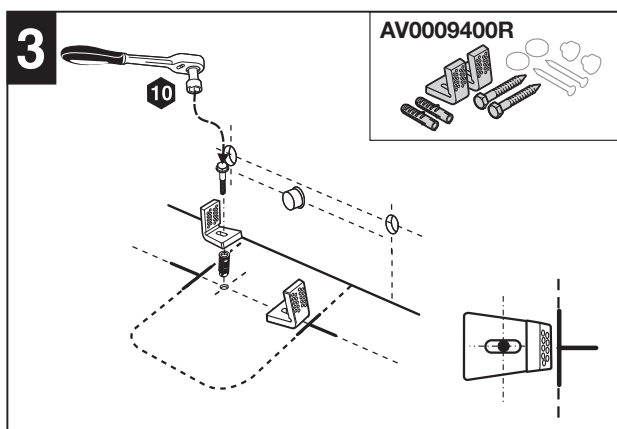

Plumbers, please ensure a copy of the installation instructions is left with the end user for future reference